

DECENTRALIZED BOW THRUSTER CONTROL

bugbw-e.mcd

Operating Unit AHD 419
on bridge and wing panels

4 wires incl. power supply
to next operating unit

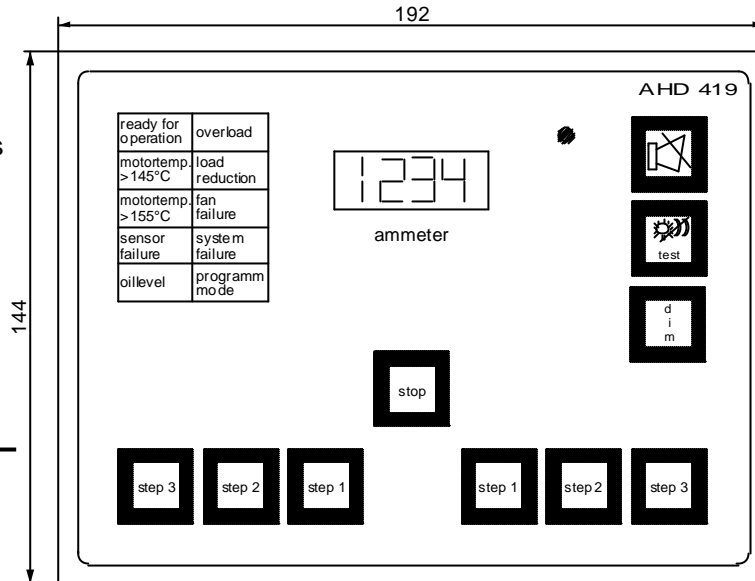

- optimized system for electronic control of bow thrusters driven by slip-ring rotor engines
- small, powerful and robust devices
- serial communication reduces required wiring to only 4 wires
- analog entry of engine current and coiling temperature; therefore no additional signal processor required
- current limiting values depend on the level and are programmable via the operating unit
- status of all in- and outputs of the central unit are visualized by LEDs: clearly and directly at the terminal blocks.
- integrated digital ammeter in the operating units
- up to four operating units connectable
- can be connected to voyage recorder with interface module AHD 425
- type-approved by: ABS, BV, DNV, GL, LRS

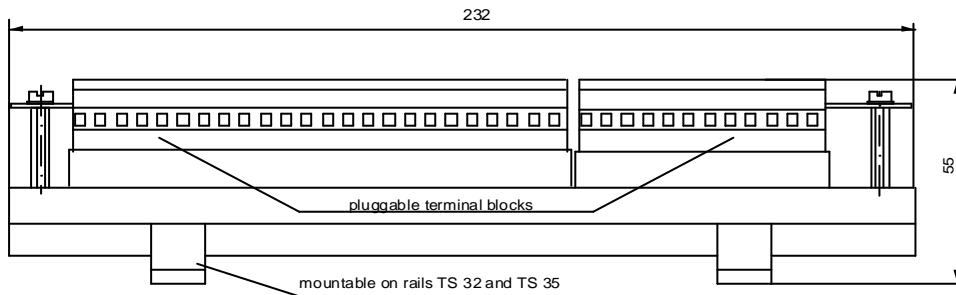

Interface Module
AHD 425
(optional)

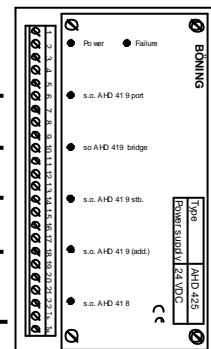

Voyage-Recorder

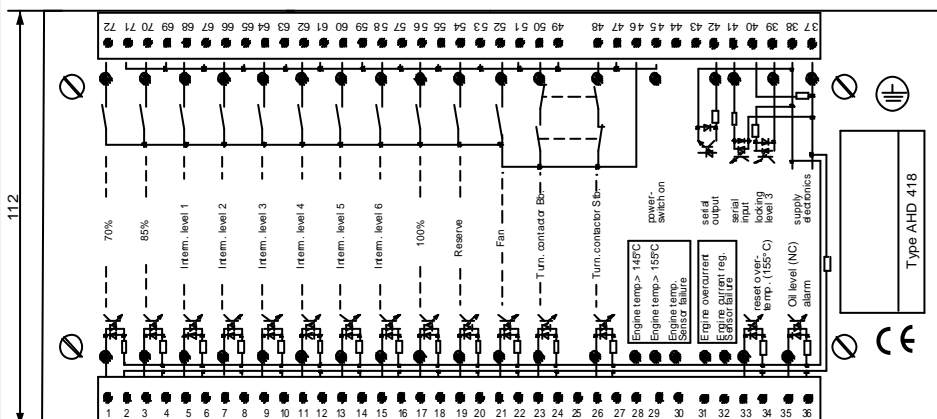

Central Unit AHD 418
at power element



Development, manufacturing, service for shipping and industry
Böning Automationstechnologie GmbH & Co. KG • Am Steenöver 4 • D-27777 Ganderkesee
Phone: +49(0)4221 9475-0 • Fax: +49(0)4221 9475-22 • Internet: www.boening.com • E-Mail: info@boening.com

Contents		Page
1.0	General	3
1.1	Construction and performance features	3
1.2	System functional description	3
2.0	Central Unit AHD 418	4
2.1	Inputs	5
2.2	Outputs	6
2.3	DIP switch settings	6
2.4	Technical data	7
2.5	Relay life	8
2.5	AHD 418 Dimensions	9
3.0	Operator and Display Unit AHD 419	10
3.1	Master operator console and the ON/OFF function	10
3.2	Alarms and indicators	10
3.3	Operator controls	12
3.4	Programming the current limit values	13
3.5	Dimensions and panel cut-out for AHD 419	14
3.6	Technical data	15
4.0	Connecting the bow thruster control to a voyage recorder	16
4.1	General	16
4.2	Construction	17
4.3	Function	17
4.4	Installation	17
4.4.1	Fitting	17
4.4.2	Equipment cabling	17
4.4.3	DIP switch settings	18
4.5	Technical data	19
4.6	Dimensions	19
4.7	Serial output protocol	20
5.0	Connection diagram for installations without a voyage recorder	21
5.1	Connection diagram for installations with a voyage recorder	22

1.0 General

The following description refers to the electronic part of the bow thruster control. The power element consists of a 3-phase asynchronous motor (slip-ring rotor) with a variable pitch propeller attached. The rotation speed, and thus motor power, is varied by switching resistances in and out of the rotor circuit. Changing the direction of rotation, and consequently the ship's direction of movement (port/starboard), is achieved by switching over two of the phases.

1.1 Construction and performance features

The bow thruster control consists of a Central Unit AHD 418, which is installed next to the power element or in the bow thruster control cabinet, and several Operator Units AHD 419. In addition there is an optional interface module AHD 425 for connecting a voyage recorder. Up to 4 Operator Units can be connected. Normally there will be one Operator Unit on the bridge and one at each bridge wing control position.

The equipment is interconnected by means of a 4-core parallel bus cable, which also includes the power supply. Communication is serial, allowing the cabling outlay to be minimised.

1.2 System functional description

The installation is connected together in accordance with the wiring diagrams on the last, or last-but-one, page of this document. The system is set in operation by means of the "ON" switch on the bridge console, and the power switch on the main switch panel. All the alarms are then simultaneously armed and the fan activated. The green annunciators on the Operator Units signal operational readiness.

On the AHD 419 control panel (see page 11) there are 3 step buttons each for port and starboard, by means of which the bow thruster can be driven in the desired direction and at the desired power level. For example, if "Step 3, Port" is selected when in the idle state, the relevant changeover contactor operates first, followed at programmable time intervals by the contactors for 70%, 85%, then a maximum of 6 intermediate steps, and finally the 100% step. There are 3 directly settable switching sequences. Other switching sequences, as well as the number of intermediate steps between 85% and 100%, are factory programmable.

During the ramping-up, the actuated contactors are checked to confirm that they have actually switched, each having a potential-free contact which is fed back to the central unit for monitoring. If this confirmation is unsuccessful, the equipment automatically switches back one step, and the "Load Reduction" and "System Failure" alarms are activated. However, if the feedback from a contact yields a positive result even though the relevant contactor was not activated, the bow thruster stops, and the "System Failure" alarm is activated.

The motor current is read by the Central Unit in analog form via the usual 1000:1 current transformer, converted to serial format and then displayed on the Operator and Display Units as a 4-digit number. (The equipment can also be factory modified to use current transformers with other division ratios). At the same time the magnitude of the current is constantly being compared with the limit set for that particular step. If the current is exceeded, the "Overload" and "Load Reduced" alarms are triggered after 10 seconds (other times on request), and the system switches simultaneously to the next lower step. If the current measured at this step is still too high, the system switches back a further step within the same clock interval, repeating until it finally stops.

- fan control and monitoring
- monitoring of the motor current and winding temperatures
- monitoring of the motor oil level
- monitoring of the contactor actuating voltage (power switch)
- controllable blocking of the 100% step
- high capacity relays for contactor control; the use of auxiliary contactors is only necessary in exceptional cases
- integrated LED status indicators for all inputs and outputs, as well as the most important alarms (over-current and over-temperature) in the AHD 418 Control Unit

2.1 Inputs

All the available inputs, together with their applicable parameters, are described below:

Input	Sensor	Delay (Sec.)	Alarm/Display		Response
			AHD 418	AHD 419	
Motor temp. 145°C Analog I/P with sensor failure monitoring sensor	PTC-Thermistor DIN44081– Triplet	7	LED (red)	motortemp. >145°C	Early warning
Motor temp. 155°C Analog I/P with sensor failure monitoring sensor	PTC-Thermistor DIN44081– Triplet	7	LED (red)	motortemp. >155°C	System shuts down.
Current 0-1500mA AC Analog I/P with sensor failure monitoring	Current txfmr 1000:1 (250:1), others on request	10	LED (red)	Overload	Reduce by one step.
Reset overtemp alarm	Contact	1	LED		Stop - Cancel 155°C overtemp. alarm.
Step 3 blocking	Contact	1	LED	Load Reduction	Power limited to 85% max.
Oil level	Contact	10	LED		Alarm triggered.
11 x contactor acknow- ledgement: step conta- ctors 70%; 85%, Z1-Z6, 100%. changeover contactors: pt; stbd	Contact	0.7	LED	System failure, Load Reduction	Alarm triggered if acknowlege- ment contact has not closed within the delay time following contactor actuation.
		1		System failure (without further message)	Alarm triggered if acknowlege- ment contact has closed <u>without</u> a contactor being actu- ated.
Fan contactor acknowledgement	Contact	3	LED	Fan failure	Alarm triggered if acknowlege- ment contact has not closed within the delay time following contactor actuation.
Power switch (230V AC)	Optocoupler	1	LED	Power switch failure	Alarm triggered if power switch fails.
Serial input	Optocoupler	5	LED extin- guishes	System failure. Display shows "E-SE"	System shuts down if no data can be received from AHD 418

Notes:

The times given in the delay column refer to the internal status of the AHD 418 Central Unit. As a result of the serial communication, including data checking, a further 1 to 2 seconds, depending on the signal, can elapse before the result is displayed on the AHD 419 control panel.

The analog motor temperature inputs have a hysteresis characteristic. The alarm ON resistance is approx. 3 kOhm, and the OFF resistance approx. 1.5 kOhm. A sensor error is generated if the resistance value is greater than approx. 25 kOhm.

During current measurement, a sensor error will be generated if any power step is activated and the current is at the same time less than 50 A. The time delay for a sensor error signal is the same as that of the corresponding alarm and is thus 7 or 10 seconds.

2.2 Outputs

All the available outputs, together with their applicable parameters, are described below:

Output	Contact	Display/Response
11 x step contactor 70%; 85%, Z1-Z6, 100%	Normally open : 250VAC, 6 Amp. resistive load. With inductive loads the contact life is reduced dependent on power factor (see page 8)	Status indication LED
2 x changeover contactor: port, starboard	Normally open: 250VAC, 16 Amp. resistive load. With inductive loads the contact life is reduced dependent on power factor (see page 8)	Status indication LED
Serial output line break	Optocoupler	LED extinguishes if line breaks. AHD 419 stops sending Data. This leads to the AHD 418 system shutting down.

2.3 DIP Switch Setting

The switching logic and switching times can be set by means of a 4-way DIP switch located beside the terminal strip (1) on the module. A further 2-way DIP switch situated beneath the cover enables the use of a different current transformer. Switch combinations not shown are reserved for internal use and may not be selected.

Factory settings are shown in **bold print**.

a) 4-way DIP switch:

Switch		Switching logic – Step sequence									
1	2	WSch	70%	85%	Z1	Z2	Z3	Z4	Z5	Z6	100%
off	off	X	-	X	X	X	X	-	-	-	X
off	on	X	X	X	X	X	X	X	X	X	X
on	off	X	X	X	X	X	-	-	-	-	X

Switch		Switching times (sec.)	
3	4	Step change	Direction change Port ⇔ Starboard
off	off	2	4
off	on	3	5
on	off	4	6

b) 2-way DIP switch:

Switch		AC current transformer ratio
1	2	
off	off	1000 : 1
on	off	250 : 1

2.4 Technical Data

Supply voltage: 24 VDC +/- 25%
 Current consumption: max. 0.3 Amp.
 Weight: 700g
 Inputs: 2 x analog for temperature acquisition (PTC-DIN44081-triplet)
 1 x analog for current acquisition
 16 x optocouplers for control, alarms, acknowledgement and communication
 Optical indicators: 38 x LED for alarm or status indication
 Outputs: 11 x contact 250VAC/1500VA for step contactors and fan
 2 x contact 250VAC/4000VA for changeover contactors, port and starboard
 1 x optocoupler for communication

2.5 Relay Life

Relays are fitted on the AHD 418 printed circuit board for controlling external contactors. The contactors do not form part of the supplied equipment, but rather are specified and fitted by the main equipment manufacturer. The following diagrams will help with their design.

Contact life period for level-, fan- and reserve relays

418r1-e.mcd

Amount of switching procedures

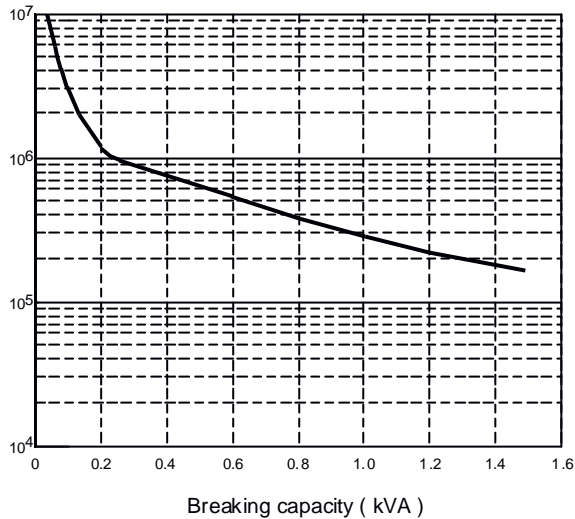

Contact life period for turning relays

Amount of switching procedures

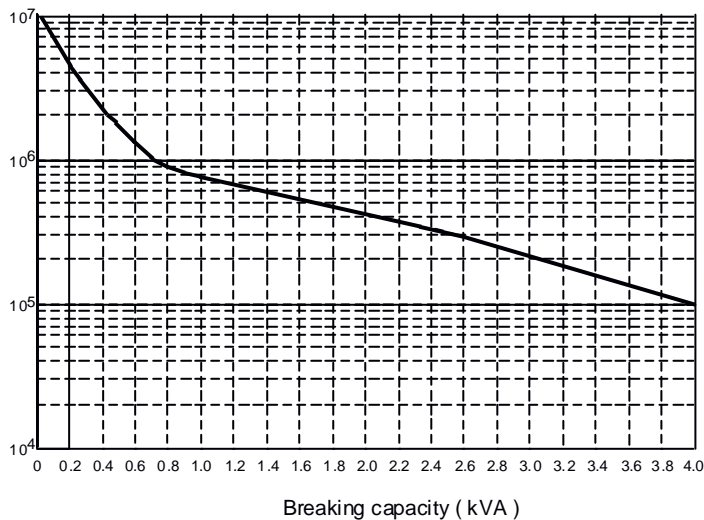

Reduction factor F

Life period reduction factor at variable cos phi

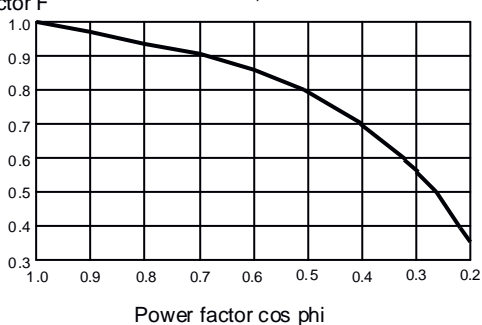

418r.doc

Parallel to the output terminals of the relays and therefore also parallel to the external power contactors, there are condensators and varistors. Both Measures prolong the life span of the relays. The diagrams are taken from the documentation from the relay manufacturer and do not take this into account.

3.0 Operator and Display Unit AHD 419

The AHD 419 Operator and Display Units are usually fitted on the ship's bridge or bridge wings. The low cabling cost also offers the possibility of mounting appropriate connector outlets, e.g. on deck, so that the bow thruster can be operated from there with a mobile unit, if required.

The front face of the equipment consists of a powder-coated, black aluminum plate, which is sealed on the top by a membrane and on the underside with an O-ring against the console. These measures ensure that the front face meets Protection Class IP 67.

The input keys are illuminated and are automatically dimmed in response to the ambient lighting by means of a photocell. This also applies to the 10-way alarm annunciator, as well as the LCD display, which gives a 4-digit indication of motor current. The maximum dimming (darkest state) in darkness is adjustable with the "dim" key.

Like the AHD 418, this module is also based on microcontroller technology and has the following performance features:

- compact construction and minimal cabling costs
- serial communication with the AHD 418 Central Unit
- simple operation of the bow thruster
- continuous display of motor current
- programmable overcurrent limits for the individual power steps
- audible and visible signalling of all alarms
- automatic and adjustable dimming of the annunciators
- potential-free contact for combined alarm indication and external horn

3.1 Master Operator Unit and the ON/OFF Function

The AHD 419 Operator Unit has an optocoupler input which can be used to switch the system on and off under program control. This is done by bridging terminals (11) and (12) with an external switch, or a keyswitch. The supply voltage can remain permanently switched on, if desired.

Important: This input may only be activated on **one** of the available Operator Units. Normally the unit on the bridge is used for this purpose. It then becomes the Master Operator Unit, thus enabling the programming function for setting the current limit values.

If the ON/OFF switching function is not wanted, the input on the Master Operator Console must be permanently bridged.

3.2 Alarms and Indicators

The AHD 419 has 10 illuminated annunciators, which, in addition to the visual indication of alarms are also intended to display status signals.

If an alarm is signalled, the relevant annunciator flashes, the internal buzzer sounds and the relay for the audible warning (horn relay) switches on. In the case of a sensor failure alarm, the annunciators for "sensor failure" and the relevant parameter flash simultaneously. Status indications are given as a steady light directly after activation.

Front view of the AHD 419 Operator Unit

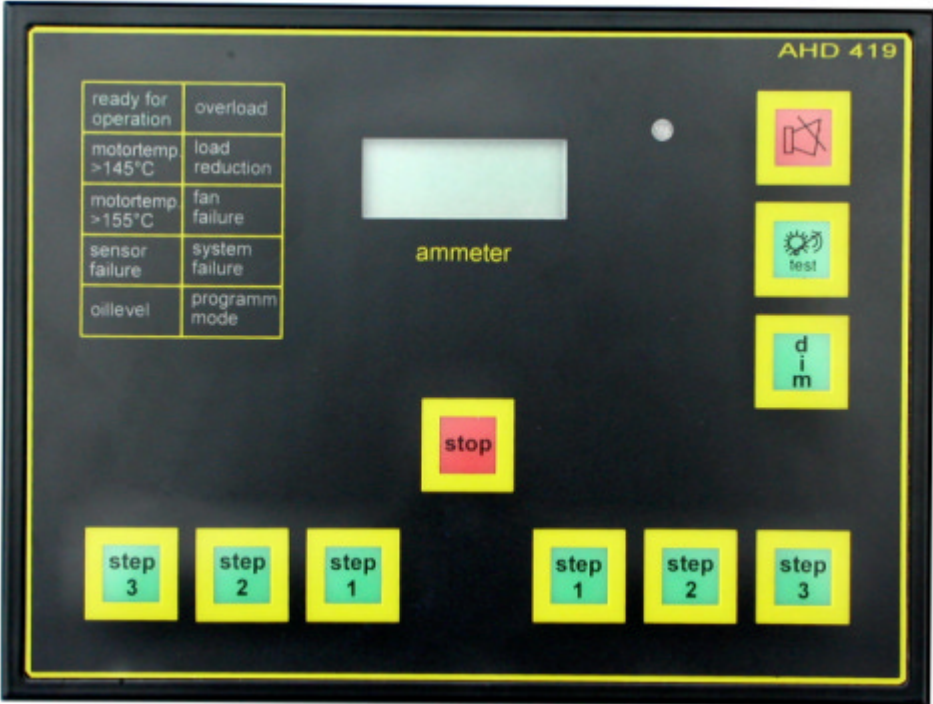

Listed below are the various alarms and indications, together with their causes and supplementary information:

Alarm	Cause	Remarks
ready for operation	Power switch ON and Master Operator Unit is ON (terminals 11, 12 bridged)	System is ready for use, provided that no serious fault has been detected
motortemp. > 145 °C	Motor winding temp. > 145 °C	Early warning
motortemp. > 155 °C	Motor winding temp. > 155 °C	System shuts down. Restart only possible by means of reset on the AHD 418.
sensor failure	Sensor failure during temperature or current acquisition	Temperature: Corresponding annunciator lights. Current: LCD display shows 4 dashes "----".
oil level	Motor oil level is too low	Alarm indication
overload step,	Motor current is too high	System reduces the power level by one or shuts down if step 1 (70%) was active.
load reduction	a) Step 3 blocking is active on AHD 418 b) Power reduction due to a current overload c) Power reduction due to incorrect acknowledgement from contactor.	Status signal indicates that full power is not available (max. 85%). Warning given in conjunction with overload alarm. Warning given in conjunction with system failure.
fan failure	Fan acknowledgement fails on the AHD 418	Alarm
system failure	a) Acknowledgement from a contactor fails b) Acknowledgement received without activation of a contactor.	Power reduction, until a conclusive state has been established in the AHD 418. If this is not possible, the system shuts down. System shuts down as this condition is indeterminate.
program-Unit mode	Programming mode for setting the current limit values was selected.	Only possible on the Master Operator

3.3 Operator Controls

The AHD 419 Operator Unit has 7 control buttons for controlling the drive steps and a further 3 buttons for the inhibit functions and setting the dimmer.

a) Control Buttons

Each direction of movement can be driven in 3 power steps. The associated control buttons are arranged on the front panel of the Operator Unit corresponding to the direction or movement. The STOP button is situated in the middle. After a button is pressed, the

corresponding power step is engaged incrementally by the bow thruster. When the actual and desired states correspond, the selected power step button is illuminated.

b) Horn inhibit



This button on the Operator Unit switches off (inhibits) the horn relay and internal buzzer when an alarm is active.

c) Visible alarm inhibit



Operation of this key causes all flashing alarms to remain permanently lit. In addition the lamp test function is invoked, i.e. all LEDs are lit and the LCD display turns on all segments.

d) Display dimming



The maximum dimming of all LEDs in darkness can be set with this key. The photocell makes reference to this setting and then automatically adjusts the light intensity to suit the prevailing ambient brightness.

3.4 Programming the Current Limit Values

Each power step is assigned a current limit value. When this is exceeded, an alarm is triggered after the delay period,. Programming can only be done via the master Operator Unit (terminals 11, 12 bridged). The procedure is described as follows:

1. Hold down the 3 buttons “Horn”, “Test” and “Dim” simultaneously for 5 seconds, until the “Program-Mode” annunciator lights. The STOP button will also light and the LCD display will indicate the number of programming operations already carried out (P001 to P999).
2. Select from the port side the power step whose limit is to be changed. The limit that is currently in effect will now be shown on the LCD display.
3. The displayed value can be reduced with the starboard step 1 button and increased with the starboard step 3 button. The changes normally take place in 5A steps. If the starboard step 2 button is pressed simultaneously, the changes will occur in 50A steps.
4. Operation of the stop key causes the currently displayed value to be stored. As confirmation the stop key lights again after approximately 2 sec., and the LCD display shows the number of completed programming operations. This number should be 1 greater than the one previously indicated. The actual data (limit values) are transmitted serially to the AHD 418 control system and stored there.
5. Further values can now be programmed as described in step 2.
6. The programming mode can be exited at any time by pressing the “Horn” button.

3.5 Dimensions and Panel Cut-out for AHD 419

41892a-e.MCD

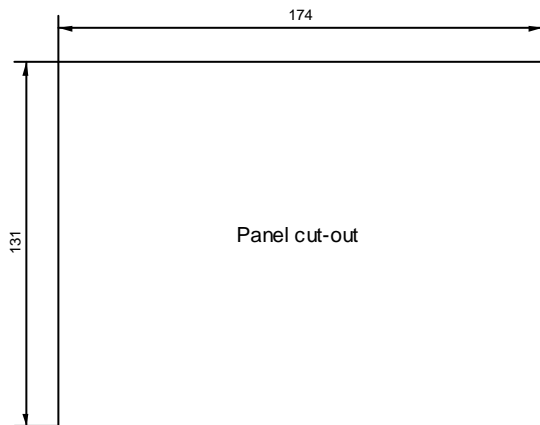
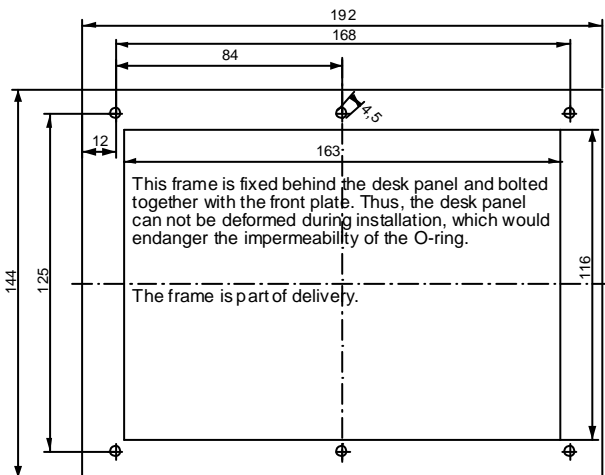
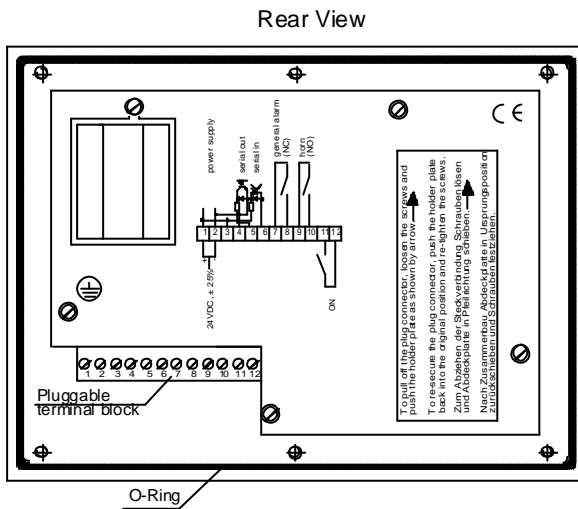
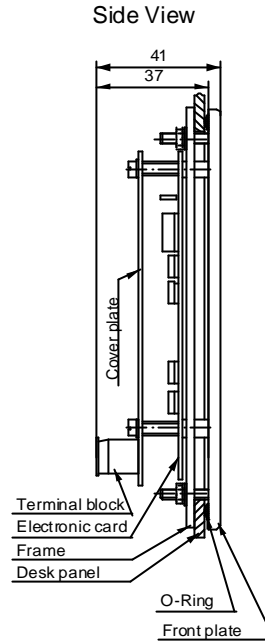
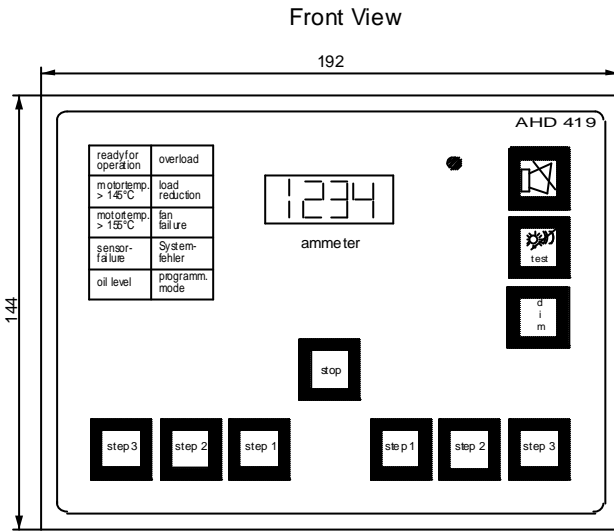

3.6 Technical Data

Supply voltage:	24 VDC +/- 25%
Current consumption:	max. 0.2 Amp
Weight:	approx. 1 kg
Inputs:	2 x optocoupler for control and communication
Outputs:	2 x contact 1A, 50VDC/AC for horn and combined alarm 1 x optocoupler for communication
Operator inputs and outputs:	7 x membrane switches for command entry, with integral indicators 3 x membrane switches for cancel and dimmer functions 10 x dimmable annunciators for alarm and status indication 1 x 4-digit LCD display with dimmable lighting
Front panel protection class:	IP66 and IP67

4.0 Connecting the Bow Thruster Control to a Voyage Recorder

4.1 General

Because of increasingly stringent safety requirements and spectacular accidents and their investigations, ever more importance is attached to the recording and storage of data, even on ships. This also includes information from bow thruster installations, and was the reason for the development of the AHD 425 interface module. It is integrated into the equipment without affecting the remaining components (AHD 418/419). Even failure of the module has no effect on the function of the bow thruster control.

Problem-free fitting is possible even with already existing installations. This should also be borne in mind when planning an installation where data storage is not yet compulsory, as it may become necessary as a result of future legislation. If, for example, a conventional “multi-core“ system is installed at the time of building the ship, a retrofit becomes very expensive and will not be completed for a few hundred Euros as is the case here.

Regulation 20 of the SOLAS guidelines of January and July 2002 stipulates that the following ships must be equipped with a voyage recorder:

1. Passenger ships which were built after 01 July, 2002.
2. Ro-Ro passenger ships, which were built before 01 July, 2002 – implementation no later than at the first test/inspection/check on or after 01 July, 2002.
3. Passenger ships, other than Ro-Ro passenger ships, which were built before 01 July, 2002 - implementation no later than 01 January, 2004.
4. Ships, other than passenger ships, of 3,000 Gross Register Tons and over, which were built on or after 01 July, 2002.

In accordance with IMO 5.4.11, commands and acknowledgements must be recorded. In our case this means:

ON/OFF
Direction of travel
Power step

The AHD 425 sends a range of additional information which can likewise be stored, if desired (see page 20, 4.7).

4.2 Construction

The AHD 425 is microprocessor-controlled module with 5 serial inputs for data acquisition and an RS422 data output for connecting to a voyage recorder, or some other recording device. The module is designed for rail mounting (TS32 and TS35). The AHD 425 consists of a printed circuit board containing the control electronics and the necessary interfaces. All connections are made by means of a 24-way pluggable terminal strip, the sockets of which are soldered into the printed circuit board.

4.3 Function

The purpose of this module is to acquire the data from all the implemented functions of the bow thruster control, to convert them to an IEC-61162-1 compliant protocol, and to transmit them over the RS422 interface.

The AHD 425 module monitors the data traffic between the bow thruster system and AHD 418/AHD 419. The data from the central control module AHD 418 represent the actual condition of the system. The data from the Operator Units AHD 419 are input as the desired states. Up to 5 serial data streams can be handled. The data from the control module AHD 418 and a maximum of 4 AHD 419 Control Units are simultaneously processed, converted to a dedicated IEC 61162-1 compliant protocol (see p20) and presented over the RS422 interface. Galvanic isolation of the RS422 interface avoids problems with cross-coupling or potential differences.

The complete record consists of an ASCII text line and is sent immediately after any change in status. If nothing changes in the status, then a periodic output is made after a DIP switch settable time interval (see 4.4.3). The record can then be stored, read and analysed by, for example, a voyage recorder.

For correct analysis, the AHD 425 module requires information about the number of Operator Units connected. This number is similarly set by means of DIP switches (see 4.4.3).

4.4 Installation and Commissioning

4.4.1 Fitting

The AHD 425 module is best mounted in the bridge console, where the terminals are then available for simultaneous distribution to the AHD 418 central control module and the AHD 419 Operator Units (see last page of this document). It is mounted on an existing TS32/TS35 rail. To avoid lateral movement, e.g. by mechanical vibration, commercially available mounts can be used, or if necessary a ground terminal on one side.

4.4.2 Equipment Cabling

The serial connections of all the modules are looped through the AHD 425, which also distributes the power supply.

In most applications, 3 Operator Units for port, bridge and starboard respectively are envisaged. The front panel legend is laid out with this in mind, i.e. the connections can be implemented exactly per the connection diagram. The AHD 419 option terminals are unused. The number of Operator Units must be set to 3 with the DIP switches (see 4.4.3). If only 2 Operator Units are used, then the connections for port and bridge are to be used. The number is then set to 2. If only 1 Operator Unit is used, then this must be connected to the bridge terminals and the number set to 1.

4.4.3 DIP Switch Setting

Before installation, the DIP switch settings must be checked and reset if necessary. Switches 1 and 2 set the number of attached Operator Units (1...4). Switches 3 and 4 set the cycle time within which the equipment outputs messages over the RS422 interface. This time applies if no changes in status occur. Should one of the data sources fail, the times can be greater than indicated.

The following settings are provided for:

Switch 1 = OFF	Switch 2 = OFF:	1 Operator Unit AHD 419 (Bridge)
Switch 1 = ON	Switch 2 = OFF:	2 Operator Units AHD 419 (Bridge, Pt)
Switch 1 = OFF	Switch 2 = ON:	3 Operator Units AHD 419 (Bridge, Pt, Stbd) *)
Switch 1 = ON	Switch 2 = ON:	4 Operator Units AHD 419 (Bridge, Pt, Stbd, Opt.)
Switch 3 = OFF	Switch 4 = OFF:	Cycle time = 10 sec.*)
Switch 3 = ON	Switch 4 = OFF:	Cycle time = 30 sec
Switch 3 = OFF	Switch 4 = ON:	Cycle time = 60 sec
Switch 3 = ON	Switch 4 = ON:	Cycle time = 1 sec (Test only)

*) Factory default settings

Front View

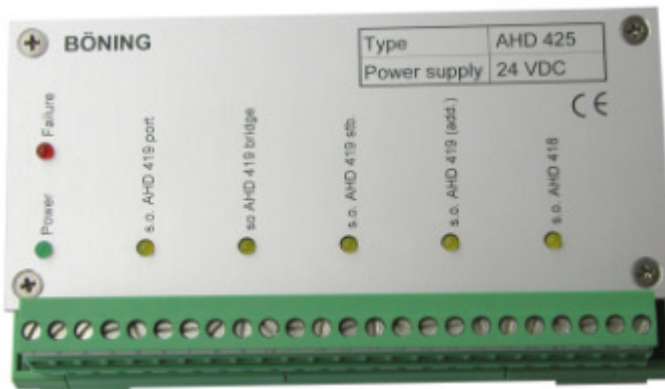

View of the red 4-way DIP switch



4.5 Technical Data

Inputs: 5 x serial I/P optically isolated (min. 1 kV)
 Outputs: 1 x RS422 galvanically isolated (min. 1 kV)
 RS232 interface also available on request
 Supply: 18 – 30VDC, max. 0.5 Amp.
 Protection class: IP00

4.6 AHD 425 Dimensions

4899b-e.mcd

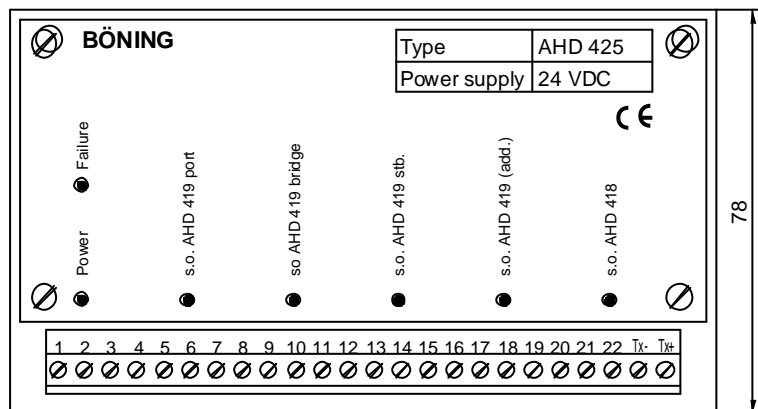
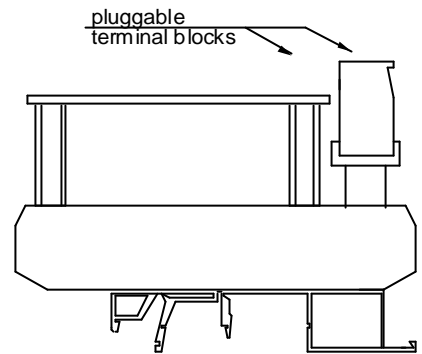
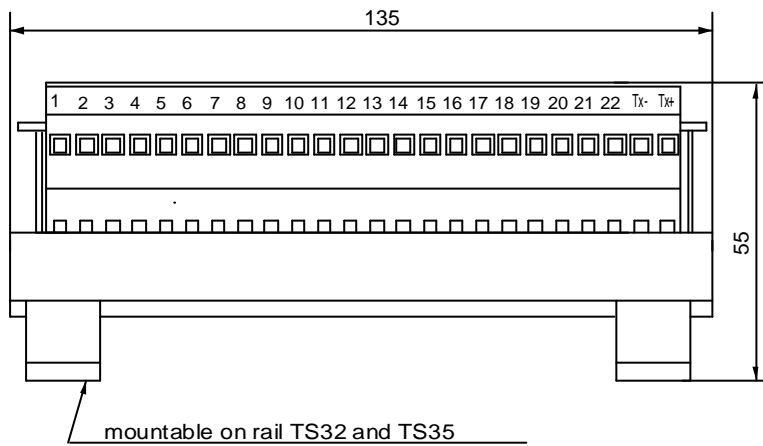

4.7 Serial Output Protocol

ahd425e.mxd

The actual value of the bow thruster, as well as the requests from the operating units for the nominal values, are registered with Module AHD425 and put out over an RS422-interface. Data output is done serially according to IEC 61162-1 (proprietary protocol).

Interface: RS422 galvanically separated (min. 1kV)/4800 Baud/8 Data/1 Stop (scheduling is done by the recipient)

Record layout/protocol:

\$PBOE,BSR,x,A,x,hh,hh,hh,hh,hh,hh,hh,hh*hh

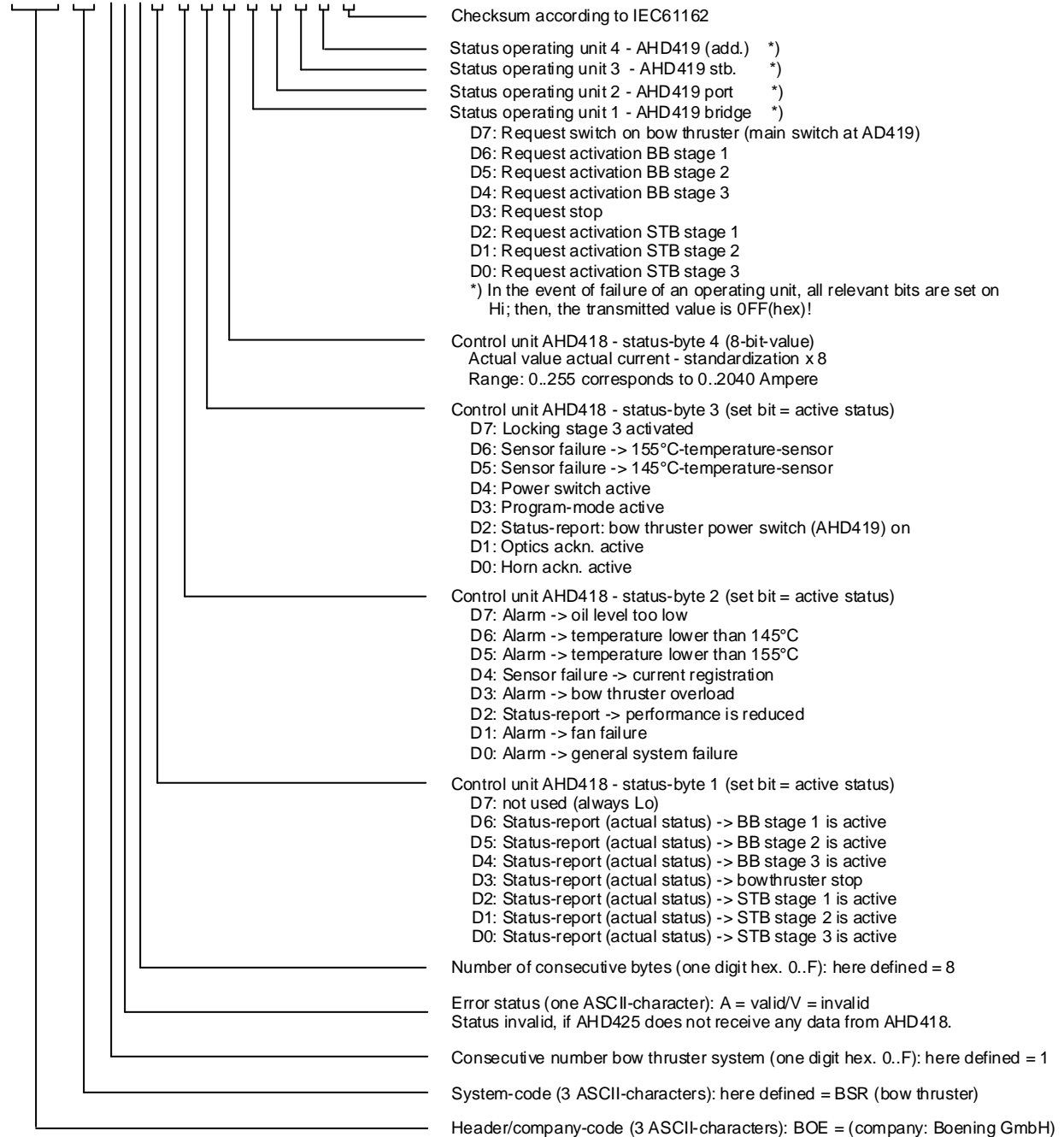

- Each record is finished with <CR> and <LF> (0Dh,0Ah).

Example 1: \$PBOE,BSR,1,A,8,08,00,14,00,80,00,00,00*16 => Basic status after activation: (system stop, power switch active, main switch is on, current = 0, request main switch on from bridge (operating unit 1))

Example 2: \$PBOE,BSR,1,A,8,20,00,14,37,80,00,00,00*18 => System is running on port stage 2, current = 470.447 Ampere

5.0 Connection Diagram for Installations without a Voyage Recorder

41891-1e.MCD

Wing

Bridge

Wing

Operating and Display Units AHD 419

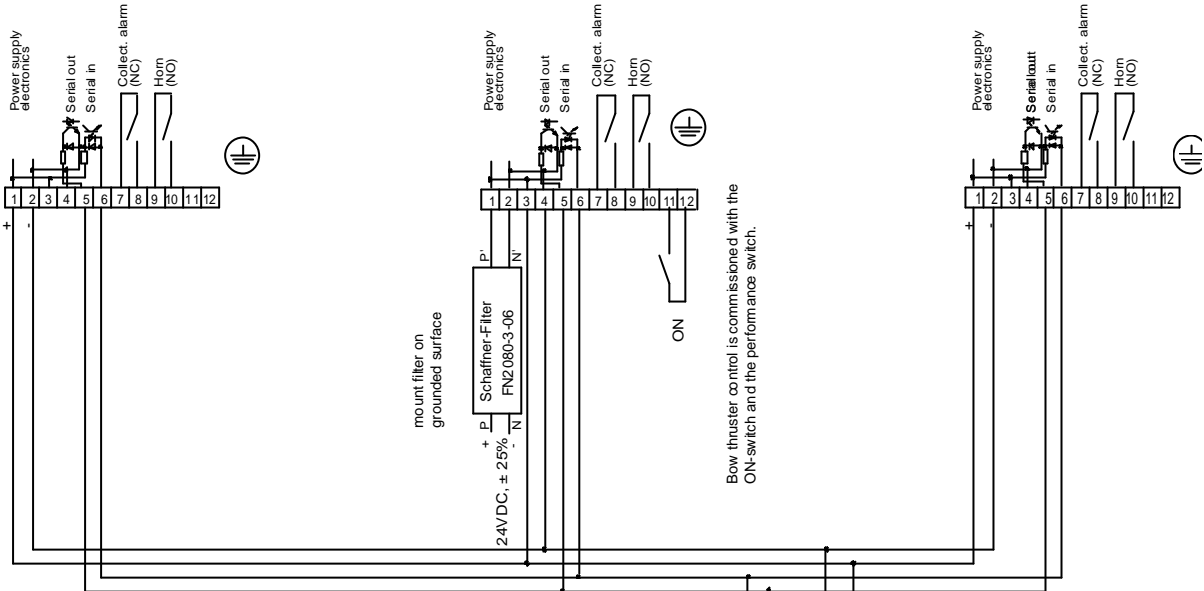

Central Control Module AHD 418

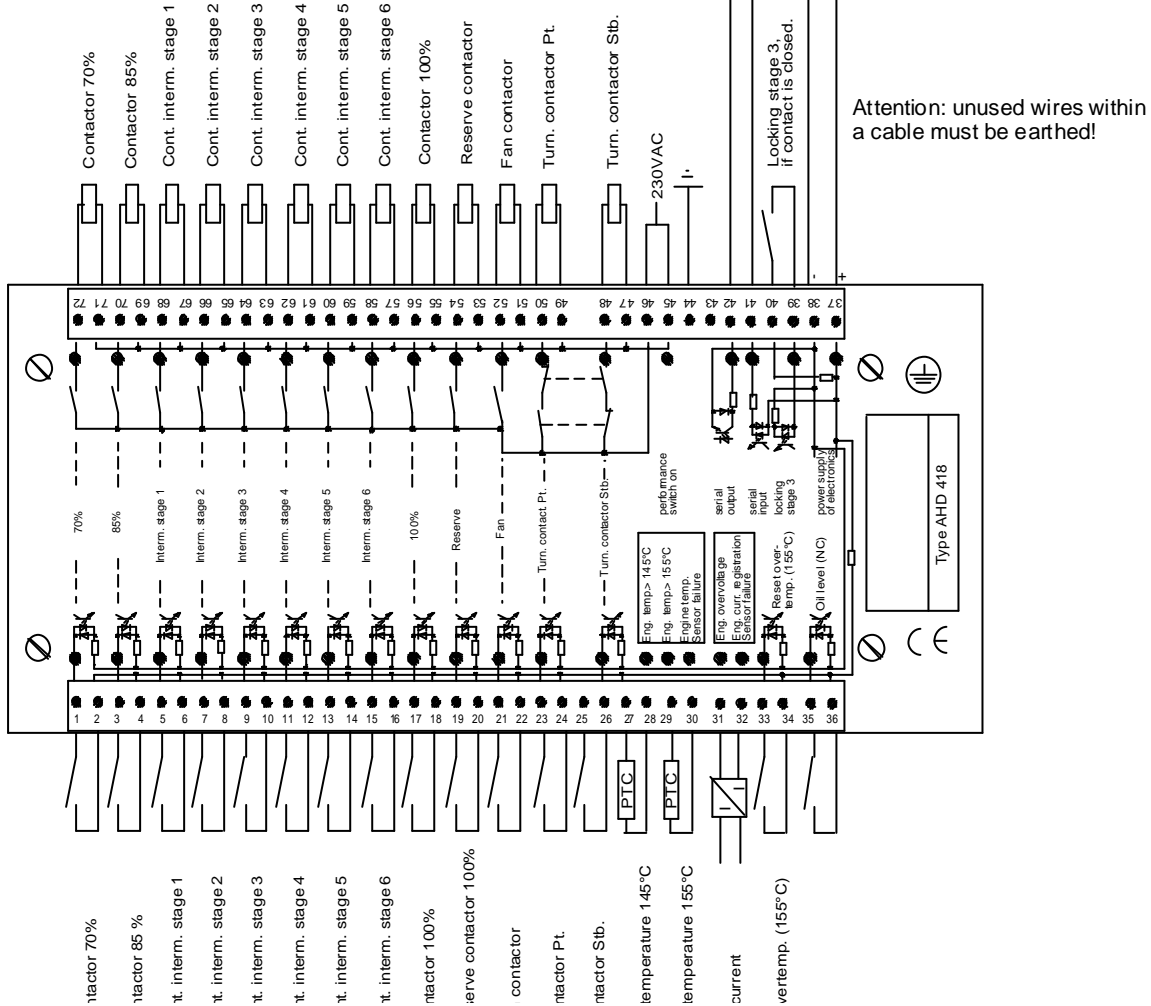

5.1 Connection Diagram for Installations with a Voyage Recorder

Control and Display Units AHD 419

